

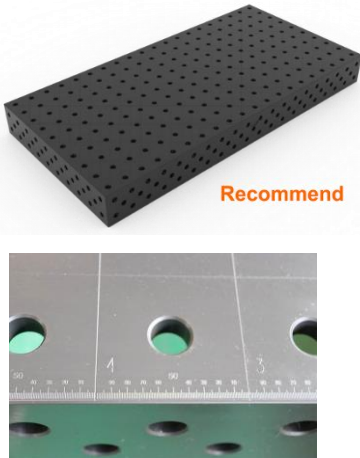

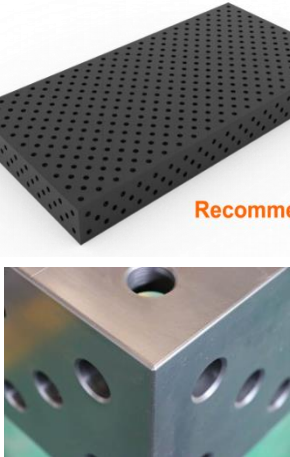







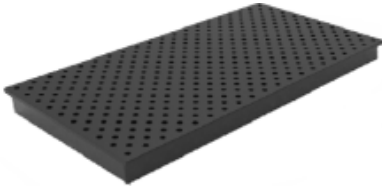
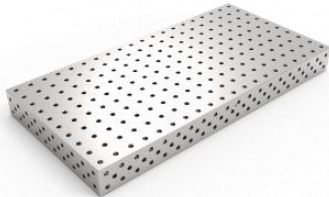

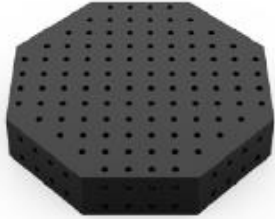



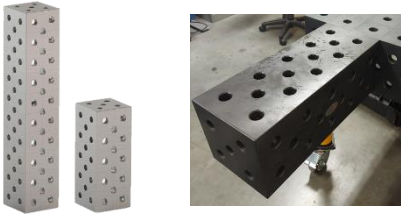
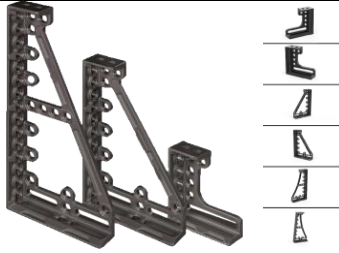





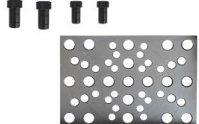
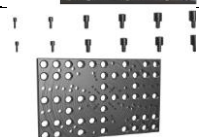









































Hitsauspöydät			
Kuvaus	Kuva	Koko (mm)	Tuotekoodi
3D nitrattu hitsauspöytä standardi / nelireikä	 <p>Recommend</p>	1000x1000x200	TA281010N
		1200x800x200	TA281208N
		1200x1200x200	TA281212N
		1500x1000x200	TA281510N
		1500x1500x200	TA281515N
		2000x1000x200	TA282010N
		2000x1200x200	TA282012N
		2000x2000x200	TA282020N
		2400x1200x200	TA282412N
		3000x1500x200	TA283015N
		4000x2000x200	TA284020N
3D nitrattu hitsauspöytä diagonaali / viisireikä	 <p>Recommend</p>	1000x1000x200	TA281010D
		1200x800x200	TA281208D
		1200x1200x200	TA281212D
		1500x1000x200	TA281510D
		1500x1500x200	TA281515D
		2000x1000x200	TA282010D
		2000x1200x200	TA282012D
		2000x2000x200	TA282020D
		2400x1200x200	TA282412D
		3000x1500x200	TA283015D
		4000x2000x200	TA284020D
2D nitrattu hitsauspöytä standardi / nelireikä		1000x1000x150	TA281010E
		1500x1000x150	TA281510E
		1200x1200x150	TA281212E
		2000x1000x150	TA282010E
		2400x1200x150	TA282412E
		3000x1500x150	TA283015E
2D nitrattu hitsauspöytä diagonaali / viisireikä		1000x1000x150	TA281010DE
		1500x1000x150	TA281510DE
		1200x1200x150	TA281212DE
		2000x1000x150	TA282010DE
		2400x1200x150	TA282412DE
		3000x1500x150	TA283015DE
3D valurauta hitsauspöytä standardi / nelireikä		1500x1000x200	TA281510C
		2000x1000x200	TA282010C
		2400x1200x200	TA282412C
		3000x1500x200	TA283015C
		4000x2000x200	TA284020C







3D valurauta hitsauspöytä diagonaali / viisreikä		1500x1000x200	TA281510CD
		2000x1000x200	TA282010CD
		2400x1200x200	TA282412CD
		3000x1500x200	TA283015CD
		4000x2000x200	TA284020CD
Nitrattu kahdeksankulmio hitsauspöytä		600x600x100	TA2860
		800x800x200	TA2880
		1000x1000x200	TA28100
		1200x1200x200	TA28120
		1400x1400x200	TA28140
1500x1500x200	TA28150		
Jalat			
Standardi jalka		D89 x 250	TU28650
		D89 x 450	
		D89 x 650	
Rullajalka		D89 x 650	TU28650.1
Säädettävä jalka		D89 x 550-900	TU28900
Kiinnittimet ja tarvikkeet			
Spacer angle – U- Shape		500x200x200	UF280500
		1000x200x200	UF281000
		1500x200x200	UF281500
		2000x200x200	UF282000
		3000x200x200	UF283000
Clamping and Locating Angle		275x100x300(left)	ZC28300.1
		275x100x300(right)	ZC28300.2
		325x100x600(left)	ZC28600.1
		325x100x600(right)	ZC28600.2
		375x100x800(left)	ZC28800.1
		375x100x800(right)	ZC28800.2

Clamping and Locating Angle		200x75x300	ZC28152
		200x75x500	ZC28162
		276x85x750	ZC28166
		276x85x750	ZC28167
Stop and Clamping Square		276x95x500	ZC28164
		276x95x500	ZC28165
Clamping Plate 350 for DIN Flanges Clamping Plate 550 for DIN Flanges		350x250x25	FP28350
		550x350x25	FP28550
Corner Module		200x200x175	JX28001
Consoles		300x200x100	FL28300
		500x200x100	FL28500
Universal Pivot and Tilt Angle		500x100x100	JD28500
Locating Tools		175x50x175 Holes/Holes	DJ28175175
		175x50x175 Slot/Slot	DJ28175175.1
		175x50x175 Holes/Slot	DJ28175175.2
		175x50x75	DJ2817575





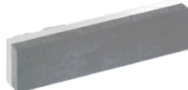









Locating Tools		75x50x75	DJ287575
		200x50x175	DJ28200175
		175x50x275	DJ28275175
		100x50x25	PC28100
		100x50x25	PC28100-02
		150x50x25	PC28150
		225x50x25	PC28225
		300x50x25	PC28300
		500x100x25	PC28500
		750x100x50	PC28750
		1000x100x50	PC281000
Plane Angle Locator		250x150x5	JP28250
Flat Angle Bracket		175x175x25	PM28175
		275x175x25	PM28275
		500x375x25	PM28500
V-block Locations		D60x135°	VX2860135
		D80x90°	VX288090
		D120x157°	VX28120157









180°Swing Clamping (Spiral Clamping)		220X270	YJ28001
90°Swing Clamping (Spiral Clamping)		270X100	YJ28002
45°Swing Clamping (Spiral Clamping)		220x270	YJ28003
screw clamp 180°Plus		220x350	YJ28001.2
Pipe Clamp Universal (45°,90°,180°)		220x270	YJ28009
Compensating screw clamp		150x350	YJ28010
Professional Fast Tension Clamp		80x250	YJ28011
Vertical Round Pipe		D28x350	YJ28012
Threaded Arbor with hexagon		150	YJ28013
Vertical Toggle Clamp with base		200x150x50	YJ28004
Push Pull (Horizontal) Toggle Clamp with base		200x100x50	YJ28005
Vertical Toggle Clamp with Adapter			YJ28007
Horizontal Toggle Clamp with Adapter			YJ28008
Eccentric Stop Ø 60		D60x25mm(Height)	GP2860







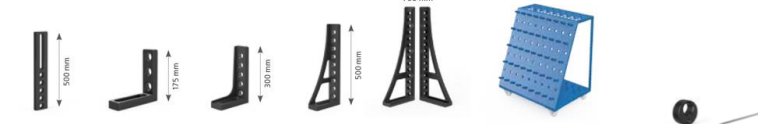



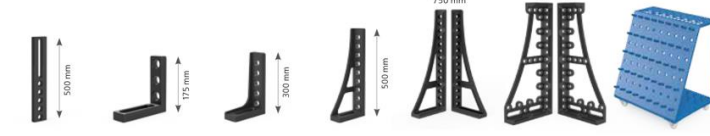
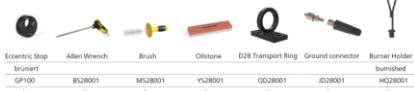

Eccentric Toggle Locating Plate		D100x25mm(Height)	GP28100
2-point Clamping Bridge		170x35x20	YT28006
Rapid Locking Pin		D28 x 50	SX28001
		D28 x 75	SX28001.1
Countersunk Head Fast Locking Pin		D28x50	SX28002
		D28x75	SX28002.1
Positioning Bolt		D28x50	DX2850
Magnetic Locking Pin		D28x25	CX2850
Magnetic Locking Pin		D28x50	CX2875
Connecting Bolt		D28x50	LX2850
Fast Clamping Bolt		D28x50	SX28510
Fast Clamping Bolt		D28x75	SX28512
Rapid Locking Pin with Handle		D28x50	SX28005
Prism Extension		D28x150	VX28649
Adjustable Spacer		D80x95 (Max Height)	TG28001
Transport Ring		Max Bearing Force: 2T	QD28001
Accessory Cart		1100x1000x650mm	GJ28001

Ground Connector		D28	JD28001
Spacer set		0.5-20	TZ28001
Hexagon Allen Wrench		14	BS28001
Nylon Brush		D30x80	MS28001
Oil Stone			YS28001
Pump Spray Bottle		1L	YF28001
Burner Holder			HQ28001

Kiinnitin setit

SET 1	      																																
	<table border="1"> <tr> <td>180°Clamp</td> <td>45°Clamp</td> <td>V-Block</td> <td>Fast Bolt</td> <td>Stop</td> <td>Stop</td> <td>Square</td> </tr> <tr> <td>burnished</td> <td>burnished</td> <td>burnished</td> <td>burnished</td> <td>Steel</td> <td>Steel</td> <td>Steel</td> </tr> <tr> <td>YJ28001</td> <td>YJ28003</td> <td>VX28090</td> <td>SX28001</td> <td>PC28150</td> <td>PC28225</td> <td>DJ28175175.2</td> </tr> <tr> <td>4 x</td> <td>2 x</td> <td>2 x</td> <td>12 x</td> <td>4 x</td> <td>4 x</td> <td>2 x</td> </tr> </table>	180°Clamp	45°Clamp	V-Block	Fast Bolt	Stop	Stop	Square	burnished	burnished	burnished	burnished	Steel	Steel	Steel	YJ28001	YJ28003	VX28090	SX28001	PC28150	PC28225	DJ28175175.2	4 x	2 x	2 x	12 x	4 x	4 x	2 x				
180°Clamp	45°Clamp	V-Block	Fast Bolt	Stop	Stop	Square																											
burnished	burnished	burnished	burnished	Steel	Steel	Steel																											
YJ28001	YJ28003	VX28090	SX28001	PC28150	PC28225	DJ28175175.2																											
4 x	2 x	2 x	12 x	4 x	4 x	2 x																											
	       																																
	<table border="1"> <tr> <td>Square</td> <td>D28 Transport Ring</td> <td>Ground connector</td> <td>Burner Holder</td> <td>Eccentric Stop</td> <td>Allen Wrench</td> <td>Brush</td> <td>Oilstone</td> </tr> <tr> <td>Casting</td> <td></td> <td></td> <td>burnished</td> <td>brüniert</td> <td></td> <td></td> <td></td> </tr> <tr> <td>280152</td> <td>QD28001</td> <td>JD28001</td> <td>HQ28001</td> <td>GP100</td> <td>BS28001</td> <td>MS28001</td> <td>YS28001</td> </tr> <tr> <td>2 x</td> <td>1 x</td> <td>1 x</td> <td>1 x</td> <td>1 x</td> <td>1 x</td> <td>1 x</td> <td>1 x</td> </tr> </table>	Square	D28 Transport Ring	Ground connector	Burner Holder	Eccentric Stop	Allen Wrench	Brush	Oilstone	Casting			burnished	brüniert				280152	QD28001	JD28001	HQ28001	GP100	BS28001	MS28001	YS28001	2 x	1 x	1 x	1 x	1 x	1 x	1 x	1 x
Square	D28 Transport Ring	Ground connector	Burner Holder	Eccentric Stop	Allen Wrench	Brush	Oilstone																										
Casting			burnished	brüniert																													
280152	QD28001	JD28001	HQ28001	GP100	BS28001	MS28001	YS28001																										
2 x	1 x	1 x	1 x	1 x	1 x	1 x	1 x																										

<p>SET 2</p>	 <table border="1"> <tr> <td>180°Clamp burnished</td> <td>45°Clamp burnished</td> <td>V-Block burnished</td> <td>Fast Bolt burnished</td> <td>Magnetic Bolt Aluminium</td> <td>Stop Steel</td> <td>Stop Steel</td> </tr> <tr> <td>YJ28001</td> <td>YJ28003</td> <td>VX28090</td> <td>SX28001</td> <td>MP2825</td> <td>PC28150</td> <td>PC28225</td> </tr> <tr> <td>6 x</td> <td>4 x</td> <td>4 x</td> <td>18 x</td> <td>4 x</td> <td>6 x</td> <td>6 x</td> </tr> </table>  <table border="1"> <tr> <td>Square Steel</td> <td>Square Casting</td> <td>Square Casting</td> <td>D28 Transport Ring</td> <td>Ground connector</td> <td>Burner Holder</td> <td>Eccentric Stop brüniert</td> </tr> <tr> <td>DJ28175175.2</td> <td>280152</td> <td>280162</td> <td>QD28001</td> <td>JD28001</td> <td>HQ28001</td> <td>GP100</td> </tr> <tr> <td>4 x</td> <td>2 x</td> <td>2 x</td> <td>1 x</td> <td>1 x</td> <td>1 x</td> <td>1 x</td> </tr> </table>	180°Clamp burnished	45°Clamp burnished	V-Block burnished	Fast Bolt burnished	Magnetic Bolt Aluminium	Stop Steel	Stop Steel	YJ28001	YJ28003	VX28090	SX28001	MP2825	PC28150	PC28225	6 x	4 x	4 x	18 x	4 x	6 x	6 x	Square Steel	Square Casting	Square Casting	D28 Transport Ring	Ground connector	Burner Holder	Eccentric Stop brüniert	DJ28175175.2	280152	280162	QD28001	JD28001	HQ28001	GP100	4 x	2 x	2 x	1 x	1 x	1 x	1 x	 <table border="1"> <tr> <td>Allen Wrench</td> <td>Brush</td> <td>Oilstone</td> </tr> <tr> <td>BS28001</td> <td>MS28001</td> <td>YS28001</td> </tr> <tr> <td>1 x</td> <td>1 x</td> <td>1 x</td> </tr> </table>	Allen Wrench	Brush	Oilstone	BS28001	MS28001	YS28001	1 x	1 x	1 x									
180°Clamp burnished	45°Clamp burnished	V-Block burnished	Fast Bolt burnished	Magnetic Bolt Aluminium	Stop Steel	Stop Steel																																																								
YJ28001	YJ28003	VX28090	SX28001	MP2825	PC28150	PC28225																																																								
6 x	4 x	4 x	18 x	4 x	6 x	6 x																																																								
Square Steel	Square Casting	Square Casting	D28 Transport Ring	Ground connector	Burner Holder	Eccentric Stop brüniert																																																								
DJ28175175.2	280152	280162	QD28001	JD28001	HQ28001	GP100																																																								
4 x	2 x	2 x	1 x	1 x	1 x	1 x																																																								
Allen Wrench	Brush	Oilstone																																																												
BS28001	MS28001	YS28001																																																												
1 x	1 x	1 x																																																												
<p>SET 3</p>	 <table border="1"> <tr> <td>180°Clamp burnished</td> <td>45°Clamp burnished</td> <td>V-Block burnished</td> <td>Fast Bolt burnished</td> <td>Magnetic Bolt Aluminium</td> <td>Stop Steel</td> <td>Stop Steel</td> </tr> <tr> <td>YJ28001</td> <td>YJ28003</td> <td>VX28090</td> <td>SX28001</td> <td>MP2825</td> <td>PC28150</td> <td>PC28225</td> </tr> <tr> <td>10 x</td> <td>6 x</td> <td>4 x</td> <td>24 x</td> <td>4 x</td> <td>8 x</td> <td>8 x</td> </tr> </table>  <table border="1"> <tr> <td>Square Steel</td> <td>Square Casting</td> <td>Square Casting</td> <td>Square Casting</td> <td>D28 Transport Ring</td> <td>Ground connector</td> <td>Burner Holder burnished</td> </tr> <tr> <td>DJ28175175.2</td> <td>280152</td> <td>280162</td> <td>280166+67</td> <td>QD28001</td> <td>JD28001</td> <td>HQ28001</td> </tr> <tr> <td>6 x</td> <td>2 x</td> <td>2 x</td> <td>1 x + 1 x</td> <td>1 x</td> <td>1 x</td> <td>1 x</td> </tr> </table>	180°Clamp burnished	45°Clamp burnished	V-Block burnished	Fast Bolt burnished	Magnetic Bolt Aluminium	Stop Steel	Stop Steel	YJ28001	YJ28003	VX28090	SX28001	MP2825	PC28150	PC28225	10 x	6 x	4 x	24 x	4 x	8 x	8 x	Square Steel	Square Casting	Square Casting	Square Casting	D28 Transport Ring	Ground connector	Burner Holder burnished	DJ28175175.2	280152	280162	280166+67	QD28001	JD28001	HQ28001	6 x	2 x	2 x	1 x + 1 x	1 x	1 x	1 x	 <table border="1"> <tr> <td>Eccentric Stop brüniert</td> <td>Allen Wrench</td> <td>Brush</td> <td>Oilstone</td> </tr> <tr> <td>GP100</td> <td>BS28001</td> <td>MS28001</td> <td>YS28001</td> </tr> <tr> <td>1 x</td> <td>1 x</td> <td>1 x</td> <td>1 x</td> </tr> </table>	Eccentric Stop brüniert	Allen Wrench	Brush	Oilstone	GP100	BS28001	MS28001	YS28001	1 x	1 x	1 x	1 x						
180°Clamp burnished	45°Clamp burnished	V-Block burnished	Fast Bolt burnished	Magnetic Bolt Aluminium	Stop Steel	Stop Steel																																																								
YJ28001	YJ28003	VX28090	SX28001	MP2825	PC28150	PC28225																																																								
10 x	6 x	4 x	24 x	4 x	8 x	8 x																																																								
Square Steel	Square Casting	Square Casting	Square Casting	D28 Transport Ring	Ground connector	Burner Holder burnished																																																								
DJ28175175.2	280152	280162	280166+67	QD28001	JD28001	HQ28001																																																								
6 x	2 x	2 x	1 x + 1 x	1 x	1 x	1 x																																																								
Eccentric Stop brüniert	Allen Wrench	Brush	Oilstone																																																											
GP100	BS28001	MS28001	YS28001																																																											
1 x	1 x	1 x	1 x																																																											
<p>SET 4</p>	 <table border="1"> <tr> <td>180°Clamp burnished</td> <td>45°Clamp burnished</td> <td>V-Block burnished</td> <td>Fast Bolt burnished</td> <td>Magnetic Bolt Aluminium</td> <td>Stop Steel</td> <td>Stop Steel</td> </tr> <tr> <td>YJ28001</td> <td>YJ28003</td> <td>VX28090</td> <td>SX28001</td> <td>MP2825</td> <td>PC28150</td> <td>PC28225</td> </tr> <tr> <td>14 x</td> <td>10 x</td> <td>6 x</td> <td>30 x</td> <td>8 x</td> <td>10 x</td> <td>10 x</td> </tr> </table>  <table border="1"> <tr> <td>Stop Steel</td> <td>Square Steel</td> <td>Square Casting</td> <td>Square Casting</td> <td>Square Casting</td> <td>Tool Cart</td> </tr> <tr> <td>PC28500</td> <td>DJ28175175.2</td> <td>280152</td> <td>280162</td> <td>280166+67</td> <td>GJ28001</td> </tr> <tr> <td>4 x</td> <td>8 x</td> <td>2 x</td> <td>2 x</td> <td>1 x + 1 x</td> <td>1 x</td> </tr> </table>	180°Clamp burnished	45°Clamp burnished	V-Block burnished	Fast Bolt burnished	Magnetic Bolt Aluminium	Stop Steel	Stop Steel	YJ28001	YJ28003	VX28090	SX28001	MP2825	PC28150	PC28225	14 x	10 x	6 x	30 x	8 x	10 x	10 x	Stop Steel	Square Steel	Square Casting	Square Casting	Square Casting	Tool Cart	PC28500	DJ28175175.2	280152	280162	280166+67	GJ28001	4 x	8 x	2 x	2 x	1 x + 1 x	1 x	 <table border="1"> <tr> <td>Eccentric Stop brüniert</td> <td>Allen Wrench</td> <td>Brush</td> <td>Oilstone</td> <td>D28 Transport Ring</td> <td>Ground connector</td> <td>Burner Holder burnished</td> </tr> <tr> <td>GP100</td> <td>BS28001</td> <td>MS28001</td> <td>YS28001</td> <td>QD28001</td> <td>JD28001</td> <td>HQ28001</td> </tr> <tr> <td>1 x</td> <td>1 x</td> <td>1 x</td> <td>1 x</td> <td>1 x</td> <td>1 x</td> <td>1 x</td> </tr> </table>	Eccentric Stop brüniert	Allen Wrench	Brush	Oilstone	D28 Transport Ring	Ground connector	Burner Holder burnished	GP100	BS28001	MS28001	YS28001	QD28001	JD28001	HQ28001	1 x	1 x	1 x	1 x	1 x	1 x	1 x
180°Clamp burnished	45°Clamp burnished	V-Block burnished	Fast Bolt burnished	Magnetic Bolt Aluminium	Stop Steel	Stop Steel																																																								
YJ28001	YJ28003	VX28090	SX28001	MP2825	PC28150	PC28225																																																								
14 x	10 x	6 x	30 x	8 x	10 x	10 x																																																								
Stop Steel	Square Steel	Square Casting	Square Casting	Square Casting	Tool Cart																																																									
PC28500	DJ28175175.2	280152	280162	280166+67	GJ28001																																																									
4 x	8 x	2 x	2 x	1 x + 1 x	1 x																																																									
Eccentric Stop brüniert	Allen Wrench	Brush	Oilstone	D28 Transport Ring	Ground connector	Burner Holder burnished																																																								
GP100	BS28001	MS28001	YS28001	QD28001	JD28001	HQ28001																																																								
1 x	1 x	1 x	1 x	1 x	1 x	1 x																																																								

<p>SET 5</p>	 <table border="1"> <tr> <td>180°Clamp burnished YJ28001 14 x</td> <td>45°Clamp burnished YJ28003 10 x</td> <td>V-Block burnished VX28090 8 x</td> <td>Fast Bolt burnished SX28001 36 x</td> <td>Magnetic Bolt Aluminium MP2825 8 x</td> <td>Stop Steel PC28150 12 x</td> <td>Stop Steel PC28225 12 x</td> </tr> </table>  <table border="1"> <tr> <td>Stop Steel PC28500 4 x</td> <td>Square Steel DJ28175175.2 12 x</td> <td>Square Casting 280152 2 x</td> <td>Square Casting 280162 2 x</td> <td>Square Casting 280166+67 1 x + 1 x</td> <td>Square Casting ZC28800.1+2 1 x + 1 x</td> <td>Tool Cart GJ28001 1 x</td> </tr> </table>	180°Clamp burnished YJ28001 14 x	45°Clamp burnished YJ28003 10 x	V-Block burnished VX28090 8 x	Fast Bolt burnished SX28001 36 x	Magnetic Bolt Aluminium MP2825 8 x	Stop Steel PC28150 12 x	Stop Steel PC28225 12 x	Stop Steel PC28500 4 x	Square Steel DJ28175175.2 12 x	Square Casting 280152 2 x	Square Casting 280162 2 x	Square Casting 280166+67 1 x + 1 x	Square Casting ZC28800.1+2 1 x + 1 x	Tool Cart GJ28001 1 x	 <table border="1"> <tr> <td>Eccentric Stop burnished GP100 1 x</td> <td>Allen Wrench BS28001 1 x</td> <td>Brush MS28001 1 x</td> <td>Oilstone YS28001 1 x</td> <td>D28 Transport Ring QD28001 1 x</td> <td>Ground connector JD28001 1 x</td> <td>Burner Holder burnished HQ28001 1 x</td> </tr> </table>	Eccentric Stop burnished GP100 1 x	Allen Wrench BS28001 1 x	Brush MS28001 1 x	Oilstone YS28001 1 x	D28 Transport Ring QD28001 1 x	Ground connector JD28001 1 x	Burner Holder burnished HQ28001 1 x	
180°Clamp burnished YJ28001 14 x	45°Clamp burnished YJ28003 10 x	V-Block burnished VX28090 8 x	Fast Bolt burnished SX28001 36 x	Magnetic Bolt Aluminium MP2825 8 x	Stop Steel PC28150 12 x	Stop Steel PC28225 12 x																		
Stop Steel PC28500 4 x	Square Steel DJ28175175.2 12 x	Square Casting 280152 2 x	Square Casting 280162 2 x	Square Casting 280166+67 1 x + 1 x	Square Casting ZC28800.1+2 1 x + 1 x	Tool Cart GJ28001 1 x																		
Eccentric Stop burnished GP100 1 x	Allen Wrench BS28001 1 x	Brush MS28001 1 x	Oilstone YS28001 1 x	D28 Transport Ring QD28001 1 x	Ground connector JD28001 1 x	Burner Holder burnished HQ28001 1 x																		
<p>SET A</p>	 <table border="1"> <tr> <td>180°Clamp 220-270mm YJ28001 16 x</td> <td>90°Clamp 100-270mm YJ28002 8 x</td> <td>145°Clamp 220-270mm YJ28003 8 x</td> <td>Fast Bolt Ø28-50mm SX28001 24 x</td> <td>Magnetic Bolt Ø28-25mm CX2825 4 x</td> <td>V-Block Ø60-135° VX2860135 4 x</td> </tr> </table>  <table border="1"> <tr> <td>Stop 150-50-25mm PC28150 10 x</td> <td>Stop 225-50-25mm PC28225 10 x</td> <td>Square 175-175-50mm DJ28175175-3 10 x</td> <td>Square 275-175-50mm DJ28275175 10 x</td> <td>Square 275-100-300mm ZC28300.1+2 1 x + 1 x</td> </tr> </table>	180°Clamp 220-270mm YJ28001 16 x	90°Clamp 100-270mm YJ28002 8 x	145°Clamp 220-270mm YJ28003 8 x	Fast Bolt Ø28-50mm SX28001 24 x	Magnetic Bolt Ø28-25mm CX2825 4 x	V-Block Ø60-135° VX2860135 4 x	Stop 150-50-25mm PC28150 10 x	Stop 225-50-25mm PC28225 10 x	Square 175-175-50mm DJ28175175-3 10 x	Square 275-175-50mm DJ28275175 10 x	Square 275-100-300mm ZC28300.1+2 1 x + 1 x	 <table border="1"> <tr> <td>Square 325-100-600mm ZC28600.1+2 1 x + 1 x</td> <td>Transport Ring Max Bearing Force: 2T QD28001 1 x</td> <td>Eccentric Stop Ø100-25mm GP100 1 x</td> <td>Byrner holder Burnished HQ28001 1 x</td> <td>Ground connector JD28001 1 x</td> </tr> </table>  <table border="1"> <tr> <td>Allen wrench BS28001 1 x</td> <td>Brush MS28001 1 x</td> <td>Oilstone Ø30-80mm YS28001 1 x</td> </tr> </table>	Square 325-100-600mm ZC28600.1+2 1 x + 1 x	Transport Ring Max Bearing Force: 2T QD28001 1 x	Eccentric Stop Ø100-25mm GP100 1 x	Byrner holder Burnished HQ28001 1 x	Ground connector JD28001 1 x	Allen wrench BS28001 1 x	Brush MS28001 1 x	Oilstone Ø30-80mm YS28001 1 x			
180°Clamp 220-270mm YJ28001 16 x	90°Clamp 100-270mm YJ28002 8 x	145°Clamp 220-270mm YJ28003 8 x	Fast Bolt Ø28-50mm SX28001 24 x	Magnetic Bolt Ø28-25mm CX2825 4 x	V-Block Ø60-135° VX2860135 4 x																			
Stop 150-50-25mm PC28150 10 x	Stop 225-50-25mm PC28225 10 x	Square 175-175-50mm DJ28175175-3 10 x	Square 275-175-50mm DJ28275175 10 x	Square 275-100-300mm ZC28300.1+2 1 x + 1 x																				
Square 325-100-600mm ZC28600.1+2 1 x + 1 x	Transport Ring Max Bearing Force: 2T QD28001 1 x	Eccentric Stop Ø100-25mm GP100 1 x	Byrner holder Burnished HQ28001 1 x	Ground connector JD28001 1 x																				
Allen wrench BS28001 1 x	Brush MS28001 1 x	Oilstone Ø30-80mm YS28001 1 x																						
<p>SET B</p>	 <table border="1"> <tr> <td>180°Clamp 220-270mm YJ28001 20 x</td> <td>90°Clamp 100-270mm YJ28002 10 x</td> <td>145°Clamp 220-270mm YJ28003 10 x</td> <td>Fast Bolt Ø28-50mm SX28001 36 x</td> <td>Magnetic Bolt Ø28-25mm CX2825 8 x</td> <td>V-Block Ø60-135° VX2860135 6 x</td> </tr> </table>  <table border="1"> <tr> <td>Stop 150-50-25mm PC28150 20 x</td> <td>Stop 225-50-25mm PC28225 20 x</td> <td>Stop 500-100-25mm PC28500 2 x</td> <td>Square 175-175-50mm DJ28175175-3 15 x</td> <td>Square 275-175-50mm DJ28275175 15 x</td> </tr> </table>	180°Clamp 220-270mm YJ28001 20 x	90°Clamp 100-270mm YJ28002 10 x	145°Clamp 220-270mm YJ28003 10 x	Fast Bolt Ø28-50mm SX28001 36 x	Magnetic Bolt Ø28-25mm CX2825 8 x	V-Block Ø60-135° VX2860135 6 x	Stop 150-50-25mm PC28150 20 x	Stop 225-50-25mm PC28225 20 x	Stop 500-100-25mm PC28500 2 x	Square 175-175-50mm DJ28175175-3 15 x	Square 275-175-50mm DJ28275175 15 x	 <table border="1"> <tr> <td>Square 275-100-300mm ZC28300.1+2 1 x + 1 x</td> <td>Square 325-100-600mm ZC28600.1+2 1 x + 1 x</td> <td>Transport Ring Max Bearing Force: 2T QD28001 1 x</td> <td>Eccentric Stop Ø100-25mm GP100 1 x</td> <td>Byrner holder Burnished HQ28001 1 x</td> </tr> </table>  <table border="1"> <tr> <td>Ground connector JD28001 1 x</td> <td>Allen wrench BS28001 1 x</td> <td>Brush Ø30-80mm MS28001 1 x</td> <td>Oilstone YS28001 1 x</td> </tr> </table>	Square 275-100-300mm ZC28300.1+2 1 x + 1 x	Square 325-100-600mm ZC28600.1+2 1 x + 1 x	Transport Ring Max Bearing Force: 2T QD28001 1 x	Eccentric Stop Ø100-25mm GP100 1 x	Byrner holder Burnished HQ28001 1 x	Ground connector JD28001 1 x	Allen wrench BS28001 1 x	Brush Ø30-80mm MS28001 1 x	Oilstone YS28001 1 x		
180°Clamp 220-270mm YJ28001 20 x	90°Clamp 100-270mm YJ28002 10 x	145°Clamp 220-270mm YJ28003 10 x	Fast Bolt Ø28-50mm SX28001 36 x	Magnetic Bolt Ø28-25mm CX2825 8 x	V-Block Ø60-135° VX2860135 6 x																			
Stop 150-50-25mm PC28150 20 x	Stop 225-50-25mm PC28225 20 x	Stop 500-100-25mm PC28500 2 x	Square 175-175-50mm DJ28175175-3 15 x	Square 275-175-50mm DJ28275175 15 x																				
Square 275-100-300mm ZC28300.1+2 1 x + 1 x	Square 325-100-600mm ZC28600.1+2 1 x + 1 x	Transport Ring Max Bearing Force: 2T QD28001 1 x	Eccentric Stop Ø100-25mm GP100 1 x	Byrner holder Burnished HQ28001 1 x																				
Ground connector JD28001 1 x	Allen wrench BS28001 1 x	Brush Ø30-80mm MS28001 1 x	Oilstone YS28001 1 x																					
<p>SET C</p>	 <table border="1"> <tr> <td>180°Clamp 220-270mm YJ28001 30 x</td> <td>90°Clamp 100-270mm YJ28002 15 x</td> <td>145°Clamp 220-270mm YJ28003 15 x</td> <td>Fast Bolt Ø28-50mm SX28001 48 x</td> <td>Magnetic Bolt Ø28-25mm CX2825 10 x</td> <td>V-Block Ø60-135° VX2860135 8 x</td> </tr> </table>  <table border="1"> <tr> <td>Stop 150-50-25mm PC28150 30 x</td> <td>Stop 225-50-25mm PC28225 30 x</td> <td>Stop 500-100-25mm PC28500 4 x</td> <td>Square 175-175-50mm DJ28175175-3 20 x</td> <td>Square 275-175-50mm DJ28275175 20 x</td> </tr> </table>	180°Clamp 220-270mm YJ28001 30 x	90°Clamp 100-270mm YJ28002 15 x	145°Clamp 220-270mm YJ28003 15 x	Fast Bolt Ø28-50mm SX28001 48 x	Magnetic Bolt Ø28-25mm CX2825 10 x	V-Block Ø60-135° VX2860135 8 x	Stop 150-50-25mm PC28150 30 x	Stop 225-50-25mm PC28225 30 x	Stop 500-100-25mm PC28500 4 x	Square 175-175-50mm DJ28175175-3 20 x	Square 275-175-50mm DJ28275175 20 x	 <table border="1"> <tr> <td>Square 275-100-300mm ZC28300.1+2 1 x + 1 x</td> <td>Square 325-100-600mm ZC28600.1+2 1 x + 1 x</td> <td>Square 375-100-800mm ZC28800.1+2 1 x + 1 x</td> <td>Transport Ring Max Bearing Force: 2T QD28001 1 x</td> <td>Eccentric Stop Ø100-25mm GP100 1 x</td> </tr> </table>  <table border="1"> <tr> <td>Byrner holder Burnished HQ28001 1 x</td> <td>Ground connector JD28001 1 x</td> <td>Allen wrench BS28001 1 x</td> <td>Brush Ø30-80mm MS28001 1 x</td> <td>Oilstone YS28001 1 x</td> <td>Accessory Cart 110-100-650mm GJ28001 1 x</td> </tr> </table>	Square 275-100-300mm ZC28300.1+2 1 x + 1 x	Square 325-100-600mm ZC28600.1+2 1 x + 1 x	Square 375-100-800mm ZC28800.1+2 1 x + 1 x	Transport Ring Max Bearing Force: 2T QD28001 1 x	Eccentric Stop Ø100-25mm GP100 1 x	Byrner holder Burnished HQ28001 1 x	Ground connector JD28001 1 x	Allen wrench BS28001 1 x	Brush Ø30-80mm MS28001 1 x	Oilstone YS28001 1 x	Accessory Cart 110-100-650mm GJ28001 1 x
180°Clamp 220-270mm YJ28001 30 x	90°Clamp 100-270mm YJ28002 15 x	145°Clamp 220-270mm YJ28003 15 x	Fast Bolt Ø28-50mm SX28001 48 x	Magnetic Bolt Ø28-25mm CX2825 10 x	V-Block Ø60-135° VX2860135 8 x																			
Stop 150-50-25mm PC28150 30 x	Stop 225-50-25mm PC28225 30 x	Stop 500-100-25mm PC28500 4 x	Square 175-175-50mm DJ28175175-3 20 x	Square 275-175-50mm DJ28275175 20 x																				
Square 275-100-300mm ZC28300.1+2 1 x + 1 x	Square 325-100-600mm ZC28600.1+2 1 x + 1 x	Square 375-100-800mm ZC28800.1+2 1 x + 1 x	Transport Ring Max Bearing Force: 2T QD28001 1 x	Eccentric Stop Ø100-25mm GP100 1 x																				
Byrner holder Burnished HQ28001 1 x	Ground connector JD28001 1 x	Allen wrench BS28001 1 x	Brush Ø30-80mm MS28001 1 x	Oilstone YS28001 1 x	Accessory Cart 110-100-650mm GJ28001 1 x																			